

PLANK[®]



MIURA stool / table

www.plank.it

Plank è un'azienda storica che ha i suoi inizi nel 1893. In linea con la filosofia aziendale volta alla ricerca, l'obiettivo di base è di indagare le possibilità tecnologiche e unirle finemente ai principi del design.

Negli ultimi anni l'azienda ha posto al centro della sua politica un forte legame con la ricerca, con la sostenibilità e con il design avvalendosi di rinomati designer come Konstantin Grcic, Naoto Fukasawa, Björn Dahlström, Ludovica + Roberto Palomba, Biagio Cisotti e Sandra Laube. La Collezione si distingue in diverse tipologie di prodotto: sedie, poltroncine, sedute lounge, sistemi di tavoli, sgabelli e complementi d'arredo. I prodotti Plank hanno ricevuto numerosi premi e riconoscimenti come il XXII Premio Compasso d'Oro ADI per la sedia MYTO e l'IF Product Design Award – Gold selection per lo sgabello MIURA e sono esposti nelle collezioni permanenti dei più importanti musei del mondo tra cui il Museum of Modern Art (MoMA) di New York, il Design Museum di Londra e l'Art Institute di Chicago.

The History of Plank begins in 1893. The basic objective has always been the investigation and intensive research for technological possibilities connected to design.

In recent years the company has placed at the center of its work a strong connection with research, sustainability and design collaborating with renowned designers such as Konstantin Grcic, Naoto Fukasawa, Björn Dahlström, Ludovica + Roberto Palomba, Biagio Cisotti and Sandra Laube. The collection has achieved distinction in a diversity of products: chairs, armchairs, lounge seating, table systems, stools. Plank products have received numerous awards and acknowledgments, for instance the XXII Compasso d'Oro ADI Design Award for the MYTO chair in addition to the IF Product Design Award – Gold selection for the MIURA stool. These products now form part of the permanent collections of some of the most important museums worldwide such as the Museum of Modern Art (MoMA) in New York, the International Design Museum in Munich, the Design Museum of London as well as the Art Institute of Chicago.

Plank ist ein traditionsreiches Unternehmen und hat seinen Ursprung im Jahre 1893. Technologie und Funktionalität, vereint durch das Design, war jeher das Ziel der Bestrebungen. Unter diesem Leitmotiv ist die Kollektion gewachsen und damit wird heute der Name Plank unverkennbar in Verbindung gebracht.

In den letzten Jahren hat das Unternehmen eine starke Verbindung zu Forschung, Nachhaltigkeit und Design in den Mittelpunkt seiner Arbeit gestellt, in Zusammenarbeit mit namhaften Designern wie Konstantin Grcic, Naoto Fukasawa, Björn Dahlström, Ludovica + Roberto Palomba, Biagio Cisotti und Sandra Laube. Die Kollektion unterscheidet sich in verschiedensten Produkt-Typologien: Stühle, Sessel, Lounge Sessel, Tischsysteme, Barhocker. Die Produkte von Plank wurden mehrfach ausgezeichnet, unter anderem mit dem XXII Compasso d'Oro ADI (MYTO chair) und dem IF Product Design Award – Gold Selection (MIURA stool) und sind in die Permanentkollektion weltweit renommierter Museen aufgenommen worden. Das Museum of Modern Art (MoMA) in New York, das Design Museum in London sowie das Art Institute in Chicago sind nur einige Beispiele.

Museums:

Die Neue Sammlung - The International Design Museum Munich, Germany - MoMA, The Museum of Modern Art, New York, USA - The Design Museum, Cape Town, South Africa - Musée du Québec, Québec city, Canada - Museum für Angewandte Kunst, Frankfurt, Germany - Triennale Design Museum, Milano, Italy - Kunststoffmuseum, Düsseldorf, Germany - The Art Institute of Chicago, USA - Museum für Gestaltung, Zürich, Switzerland - Deutsches Museum, München, Germany - Vitra Design Museum, Weil a. Rhein, Germany - Bröhan Design Foundation, Berlin, Germany - Denver Art Museum, USA - Badisches Landesmuseum, Karlsruhe, Germany - The Design Museum, London, Great Britain - Jerusalem Design Museum, Israel - Designsammlung Uni Wuppertal, Germany - Bergische Universität Wuppertal, Germany - Design Museum Helsinki, Finland - Indianapolis Museum of Art, USA.

design Konstantin Grcic **MIURA stool**



2

design Konstantin Grcic **MIURA table**



10



10



10



12





Peacock Club, Göteborg



Sampan Graffiti Bar, Philadelphia



Winter garden and cafeteria. Die Neue Sammlung – The International Design Museum / Pinakothek der Moderne, Munich



Secret Garden Bar at South Place Hotel, London



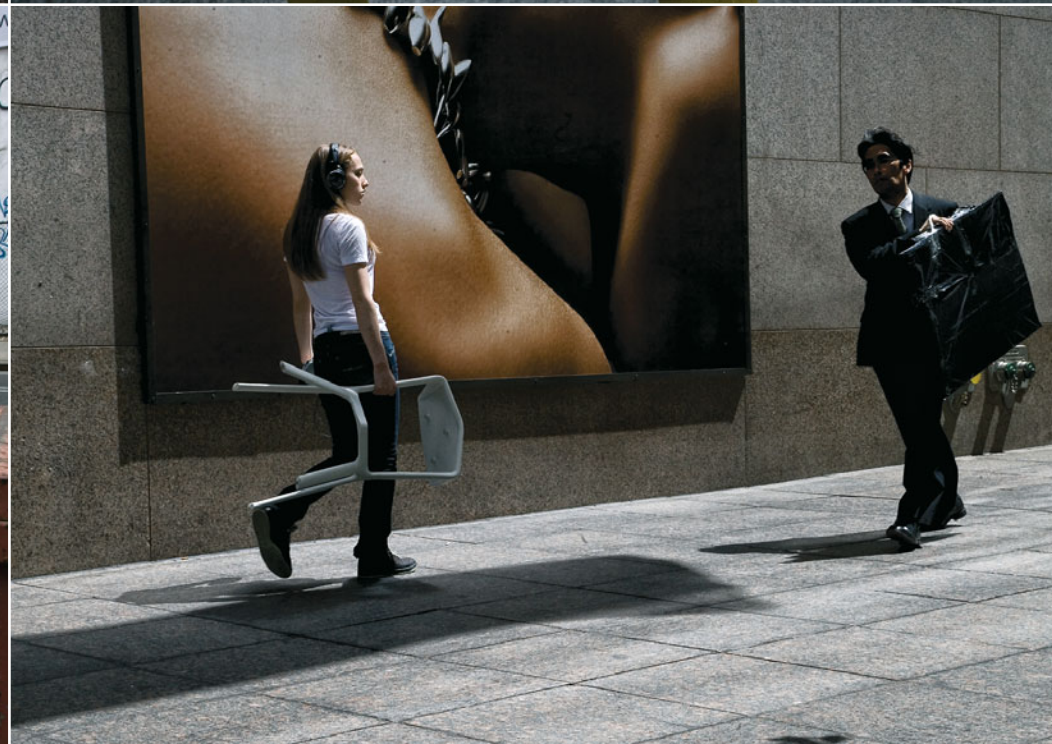







MIURA stool
design Konstantin Grcic

Mod. 8200-00

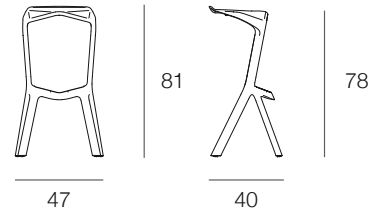

Sgabello in polipropilene nei colori nero, bianco, arancio puro, rosso traffico, rosso vino, azzurro, giallo verde. Impilabile. Uso interno ed esterno, riciclabile.

Stool made of polypropylene available in black, white, pure orange, traffic red, wine red, light blue, yellow green. Stackable. Indoor and outdoor use, recyclable.

Barhocker aus Polypropylen in den Farben schwarz, weiß, reinorange, verkehrsrot, weinrot, hellblau, gelbgrün. Stapelbar. Innen- und Außenbereich, recyclebar.

Carelo di Trasporto.

Transport trolley.

Transportwagen.

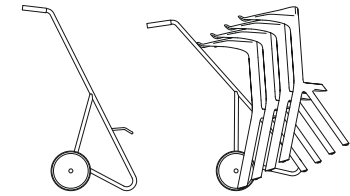

Finiture / Finishings / Ausführungen



arancio puro, pure orange, reinorange



rosso vino, wine red, weinrot

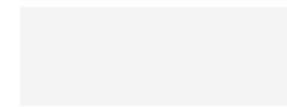

bianco, white, weiss



azzurro, light blue, hellblau



giallo verde, yellow green, gelbgrün



rosso traffico, traffic red, verkehrsrot



nero, black, schwarz

MIURA table
design Konstantin Grcic

Mod. 9553-51

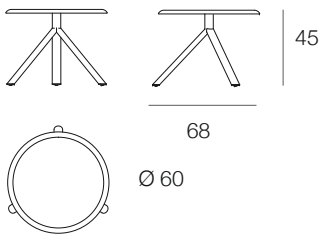

Sistema di tavolo pieghevole, struttura in acciaio verniciato a polvere, piani in acciaio, MDF o HPL Full color nei colori nero, bianco e rosso (solo metallo). Piano tavolo ribaltabile.

Table system, structure in powder coated metal, table top in metal, HPL full color in the colors black, white, red (metal only). With folding table top.

Tisch System, Gestell in pulverbeschichtetem Metall und Platte in Metall, MDF oder Vollaminat HPL in den Farben schwarz, weiß, verkehrsrot (nur Metall). Tischplatte klappbar.

Mod. 9553-01

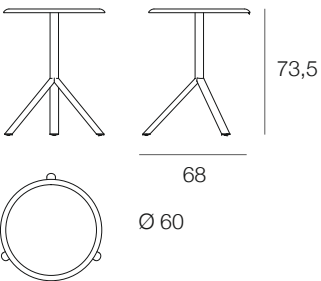

Mod. 9553-71

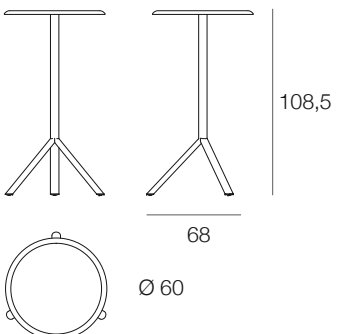

Mod. 9590-51 (Ø 70)

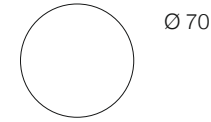
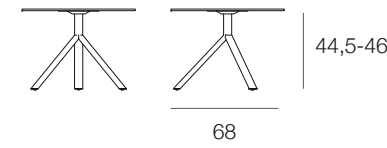

Mod. 9580-51

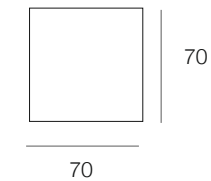
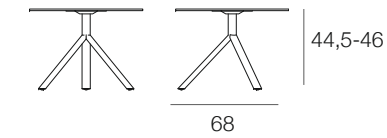

Mod. 9590-01 (Ø 70)
Mod. 9591-01 (Ø 80)
Mod. 9592-01 (Ø 90)

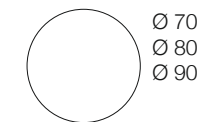
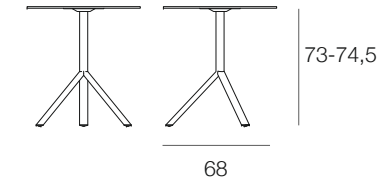

Mod. 9580-01

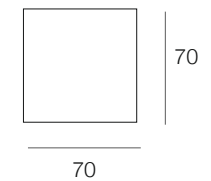
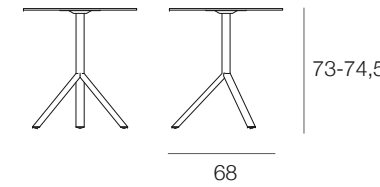

Mod. 9590-71 (Ø 70)
Mod. 9591-71 (Ø 80)

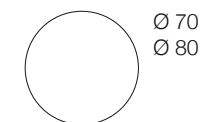
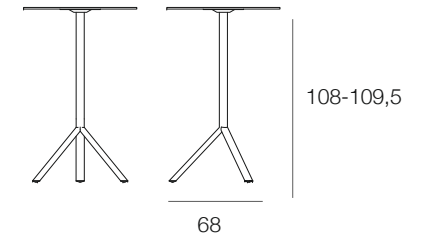

Mod. 9555-01 (Ø 100)
Mod. 9556-01 (Ø 110)

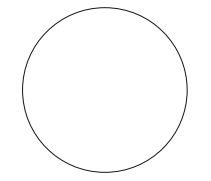
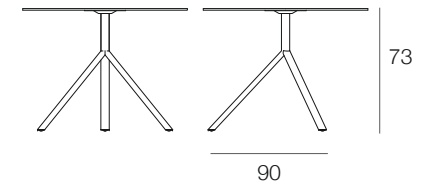

Finiture tavolo / Table Finishings / Tischausführungen

Piano in metallo / metal table top / Metalltischplatte (Mod. 9553)

MDF verniciato / powder coated / pulverbeschichtet

HPL - Full color



nero, black, schwarz

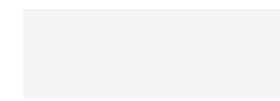

bianco, white, weiss

solo per / only for / nur für Mod. 9553

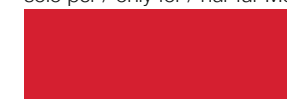

rosso traffico, traffic red, verkehrsrot

Dimensioni piani tavolo speciali su richiesta.

Colori e verniciature speciali su richiesta basate sulla gamma RAL. Esecuzioni ignifughe (vernice, espanso su richiesta). Tutti i legni sono certificati FSC.

Custom table top sizes on request. Custom colors and finishes according to RAL card on request. Flame retardant executions (varnish, polyurethane foam) on request. All woods are FSC certified.

Tischplatten Sondermaße auf Anfrage. Sonderfarben und Lackierungen laut RAL-Karte auf Anfrage. Feuerhemmende Ausführungen (Lack, Schaumstoff) auf Anfrage. Alle Hölzer sind FSC zertifiziert.

Riconoscimenti / Awards / Auszeichnungen:

- 100% Design Blueprint Best Product Award 2005
- Interior Innovation Award imm Cologne 2006 - Best of the Best in Category Best Item
- Red Dot: Product Design Award Winner 2006
- IF Product Design Award 2006 - Gold selection
- Design Award of the Federal Republic of Germany 2007, - Silver Award
- Interior Innovation Award imm Cologne 2008 - Best of the Best in Category Best Detail (Miura table)

Collezioni / Collections / Kollektionen:

- Die Neue Sammlung - The International Design Museum / Pinakothek der Moderne, München, Germany
- Museum für Gestaltung, Zürich, Switzerland
- MoMA - The Museum of Modern Art, New York, USA
- Art Institute of Chicago, USA
- Triennale Design Museum, Milano, Italy

Publicazioni / Publications / Publikationen:

- MIURA stool, photographed by Florian Böhm, NYC 2006, - Plank ISBN 978-88-902728-0-6



© 2014 Plank Srl - International Deposit of Industrial Design

Graphic design: Sandra Laube Product Photography: Matteo Imbriani Reference Photography: Guy Montagu-Pollock (p.7), Florian Böhm (p.8-9)

